



[User Guide](#)

[Manuel de l'utilisateur](#)

[Gebrauchsanleitung](#)

[Manuale di istruzioni](#)

[Guía del usuario](#)

[Gebruikers-handleiding](#)

[Brugervejledning](#)

[Användarhandbok](#)

[Instrukcja obsługi](#)

[Használati útmutató](#)

ScoopFree™ SmartSpin™

Self-Cleaning Litter Box



Når du opsætter din nye kattebakke, skal du huske på:

Nogle katte har brug for tid til at justere

Mens mange katte tager til deres nye og forbedrede kattebakke med det samme, tager andre lidt længere.

Her er nogle tips til at hjælpe dig med at komme godt i gang:

- Placer din nye ScoopFree™ SmartSpin™ selvrensende kattebakke ved siden af din kats nuværende kattebakke. (Du kan snart slippe af med den gamle).
- Lad den gamle kattebakke blive snavset. De fleste katte foretrækker en ren kattebakke og vil snart blive tegnet til det friske kuld.

- Selvom den ScoopFree™ SmartSpin™ selvrensende kattebakke er stille, når den løber og kører kun efter brug, i nogle tilfælde er det en god ide at lade den nye kattebakke være trukket ud af stikkontakten indtil din kat får styr på det.

Din killing har brug for særlig pleje

Vigtigt: Hvis du har en killing, skal du lade kattebakken være trukket ud af stikkontakten (eller slukke for automatisk rengøring funktion i appen) og øs affald manuelt, indtil hun vejer mindst 1 kg og 6 måneder gammel. Du vil måske placere en kasse eller træde foran kattebakken for at gøre det nemmere for at hun kan komme ind og ud.

Hvad du har,

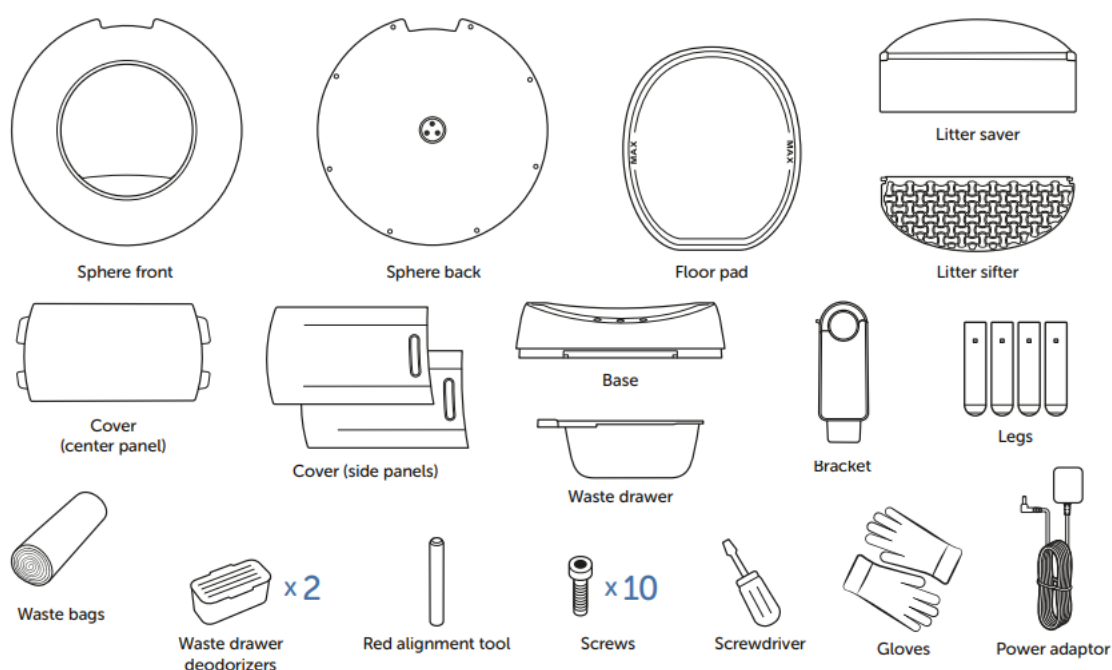

Det skal du bruge:

- Trådløs router (2,4 GHz)
- Højhastigheds internetforbindelse
- Smartphone

Sætte kattetoiletet op efter billederne

1 Assemble the base

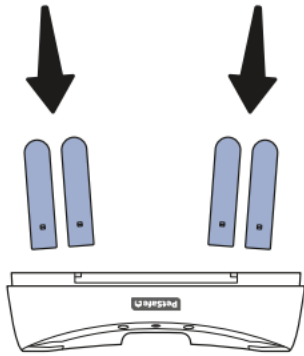

2

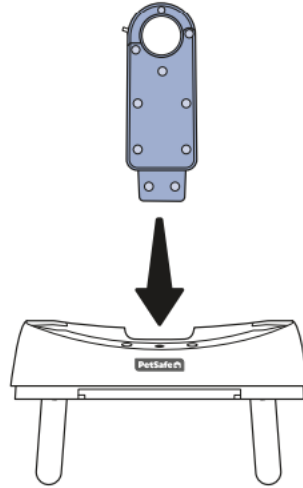

3

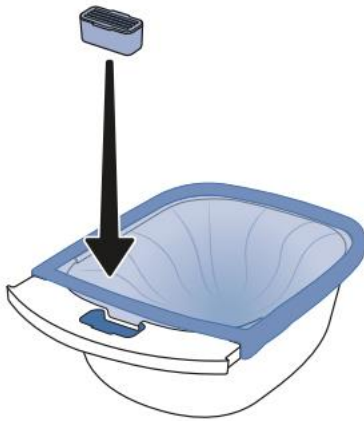

4

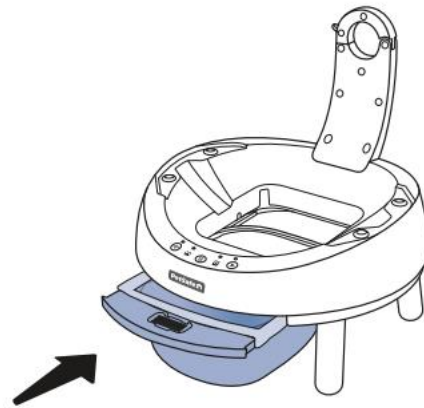

5 Assemble the sphere

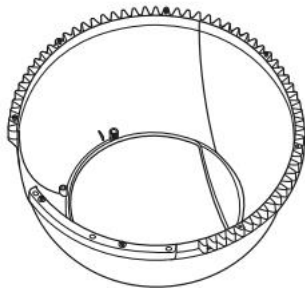

6

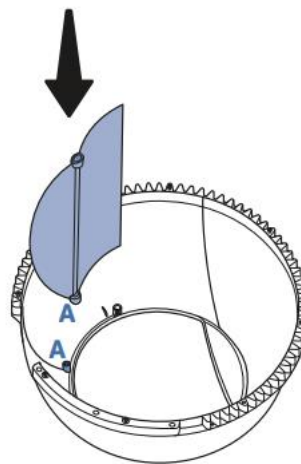

7

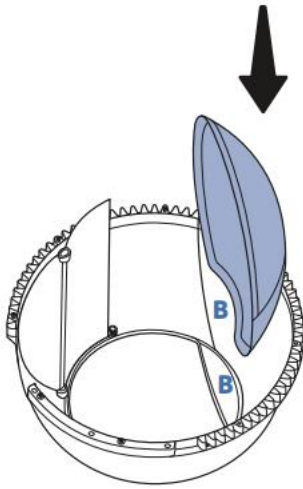

8

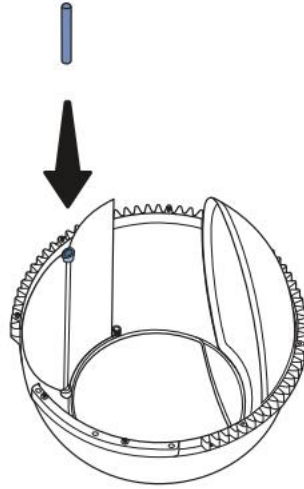

9

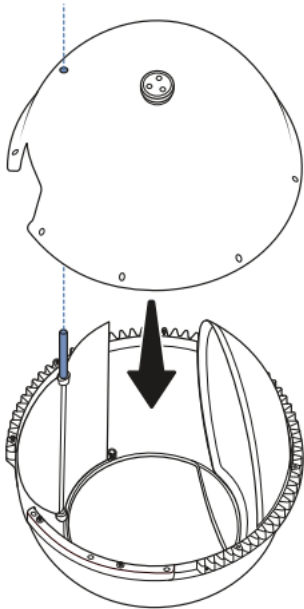

10

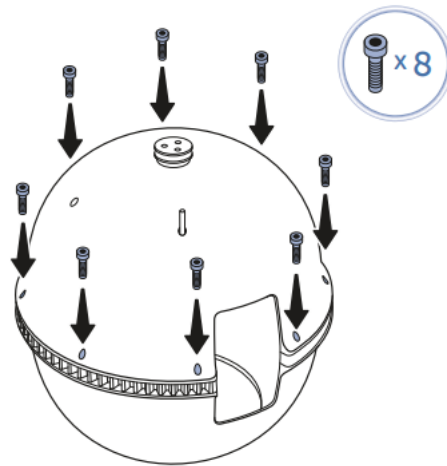

11 Install the litter sifter

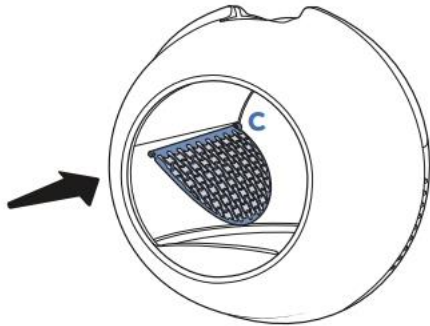

12

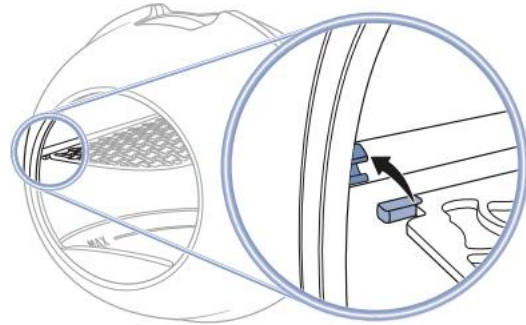

13 Place the sphere on the base

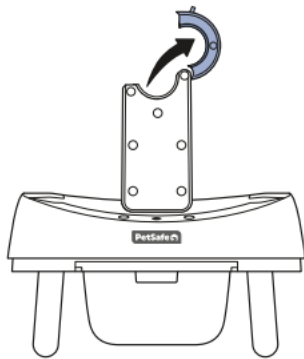

14

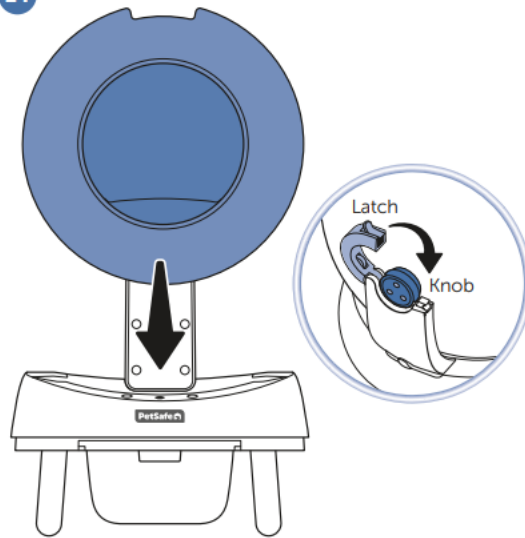

15 Assemble the cover

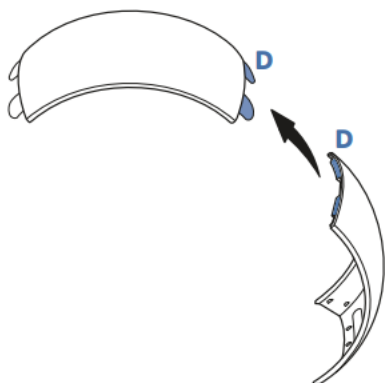

16

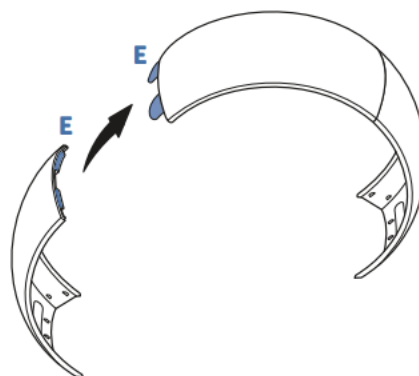

17 Install the cover

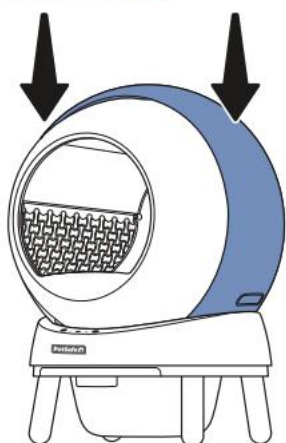

18 Plug in the litter box

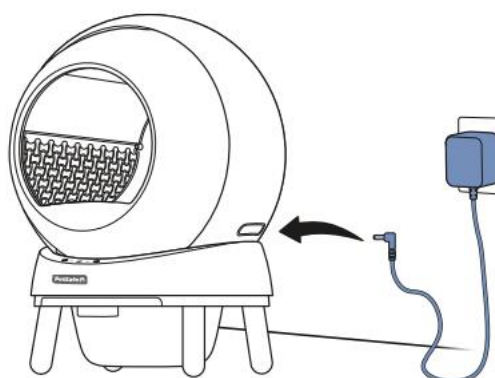

19 Add litter

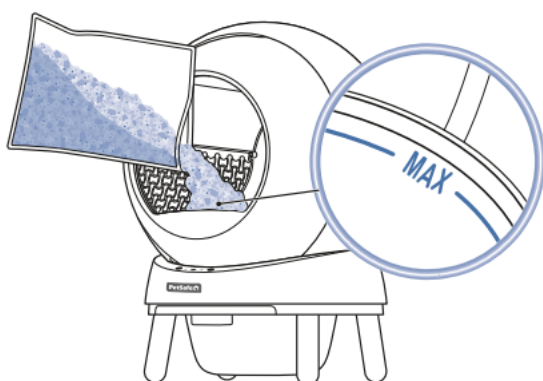

20 Download the app and connect



Scan QR-koden ovenfor for at downloade PetSafe®SmartSpin™ app.

Når du har downloadet og åbnet appen, skal du trykke på og hold Wi-Fi-knappen på kattebakken nede i 3 sekunder for at gå ind i paring. Wi-Fi-lyset begynder at blinke. I appen skal du følge instruktionerne på skærmen for at tilføje kullet boksen til appen og tilslut den til dit Wi-Fi-netværk. Når kattebakken er tilsluttet, vil Wi-Fi-lyset lyse solid.

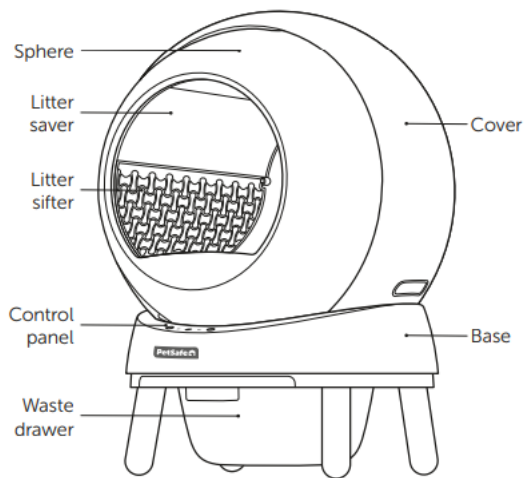

- En vægtsensor inde i kattebakken registrerer hvornår din kat er til stede. Katteindgangslyset vil lyse når en vægtændring på mere end 2,5 pund (1 kg) er opdaget.
- Når din kat forlader kattebakken, lyser katteindgangen slukker, begynder rengøringslyset at blinke, og rengøringstimeren starter en 3-minutters nedtælling. (Du kan ændre længden af denne nedtælling i appen.)
- Når nedtællingen er færdig, vil kattebakken start rengøringscyklussen. Kuglen vil langsomt rotere 180 grader. Når kuglen roterer, vil ubrugt affald falde gennem kuldsigten og opbevares bag kullet opsparer. Klumpet affald og affald forbliver ovenpå affaldssigten og deponeres i affaldsskuffen. Kuglen vil derefter rotere tilbage til sin startposition, at sprede det ubrugte affald jævnt over bunden af kattebakke.
- Hvis din kat vender tilbage til kattebakken under nedtællingen, timeren stopper. Nedtællingstimeren nulstilles når din kat forlader kattebakken igen.
- Du kan starte rengøringscyklussen til enhver tid ved at trykke på rensenap i 1 sekund. For at sætte rengøringscyklussen på pause, tryk på rensenappen igen. (Du kan også starte og stop rengøringscyklussen i appen.)

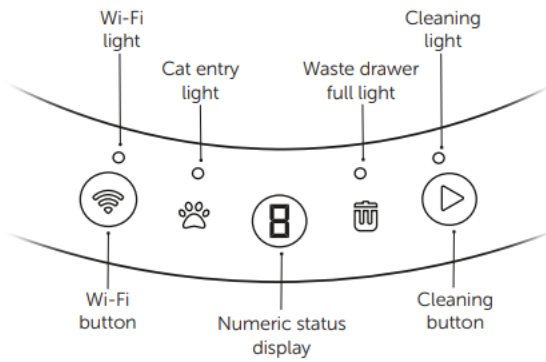

Button	Usage
Wi-Fi button	Press and hold this button for 3 seconds to enter pairing mode.
Cleaning button	Press the cleaning button for 1 second to manually start the cleaning cycle. To pause or resume the cleaning cycle while it is in progress, press the cleaning button again. Press and hold the cleaning button for 3 seconds to enter Add Litter mode. After adding litter to the litter box, press the cleaning button again to exit Add Litter mode.

Light	Meaning
Wi-Fi light	<ul style="list-style-type: none"> Solid white: The litter box is connected to Wi-Fi. Blinking white: The litter box is not connected to Wi-Fi.
Cat entry light	<ul style="list-style-type: none"> Solid white: A weight change of more than 2.5 lb (1.1 kg) has been detected. Off: No weight change has been detected.
Waste drawer full light	<ul style="list-style-type: none"> Solid white: The waste drawer is full. Off: The waste drawer is not full.
Cleaning light	<ul style="list-style-type: none"> Solid white: The cleaning cycle is in progress. Blinking white: The cleaning cycle countdown has been initiated.
Numeric status display	<p>This display provides information about the litter box operating mode and alerts you to any error conditions:</p> <ul style="list-style-type: none"> A: Add Litter mode is enabled. L: Child lock is enabled; the control panel buttons are locked. P: Sleep mode is enabled; the litter box will not run the cleaning cycle during the selected time period. 1: The infrared sensor in the base is blocked. 2: The cover is not installed. 3: Abnormal motor current. 4: Sphere not installed. <p>See the app for more information about litter box operating modes and error conditions.</p>

Tøm affaldsskuffen og tilføj frisk affald sådan her

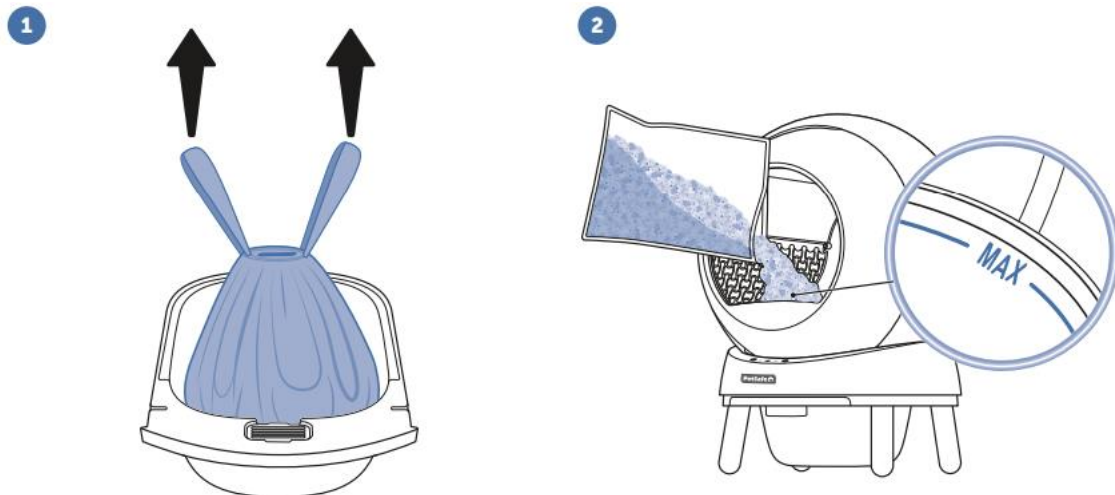

rens det sådan her

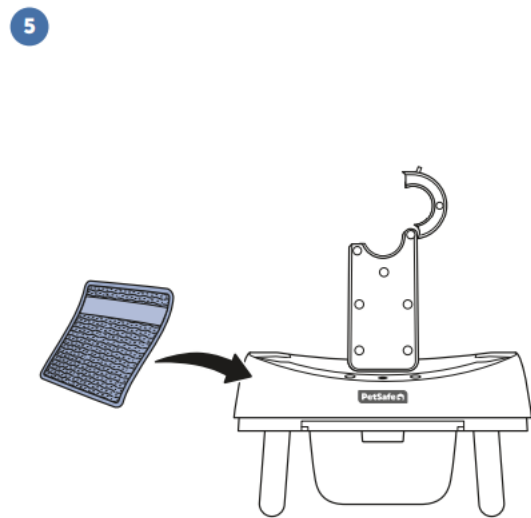
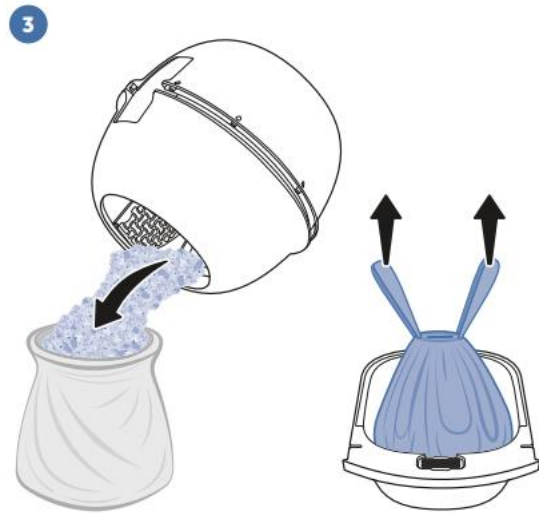
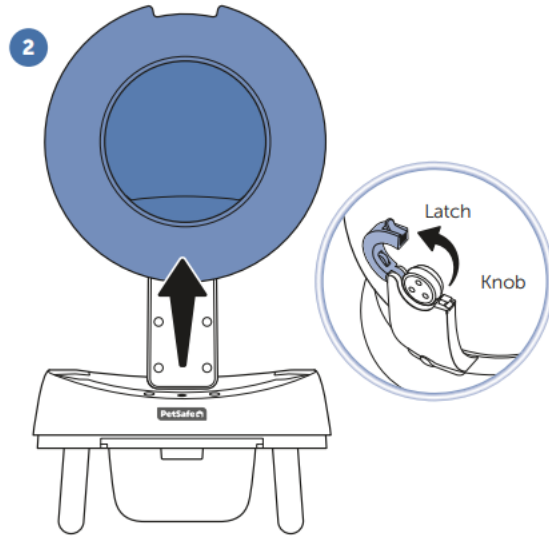
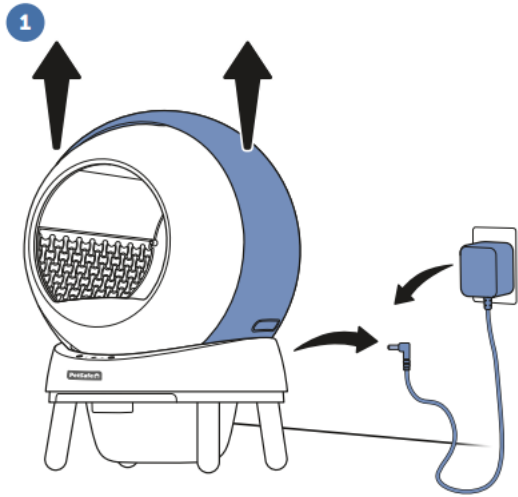

Tips og tricks

Når du tilføjer kattegrus, skal du bruge "tilføj kattegrus" funktionen hvis der allerede er nok, "A" vil ikke blive vist.. Når A er synlig er der for lidt.. Det andet link viser hvordan du kan lave en nulstilling.

Vi har sjældent et problem med disse, så kan du venligst trække netledningen ud af væggen og smart spin. Sæt strømkablet i igen og kontroller, at det ikke sidder fast i en ødelagt forlængerledning eller lignende. Tjek, at delen, der skal ind i Smart Spin, er skubbet langt nok ind.

Flere tips her,

<https://support.petsafe.net/articles/my-petsafe-smartspin-self-cleaning-litter-box-will-not-go-into-add-litter-mode/>

og hvis det ikke virker, så prøv dette.

<https://support.petsafe.net/articles/my-petsafe-scoopfree-smartspin-self-cleaning-litter-box-will-not-clean/>

Kontakt kundeservice <https://intl.petsafe.net/en-dk/support/contact-us>

PS : [PAC00-17984](#) Scoopfree Clumping Waste Bin Liners (x25) tilgjengelig

ScoopFree™ SmartSpin™

Self-Cleaning Litter Box



När du sätter upp din nya kattlåda, kom ihåg:

Vissa katter behöver tid att anpassa sig. Medan andra katter gillar till sin nya och förbättrade kattlåda direkt, för andra tar det lite längre. Här är några tips som hjälper dig att komma igång bra:

- Placera din nya SmartSpin™ självrengörande kattlåda bredvid din katts nuvarande kattlådan. (Du kommer snart att kunna bli av med den gamla, tjohoo!).
- Låt den gamla kattlådan bli smutsig. De flesta katter föredrar en ren kattlåda och kommer snart att dras till den rena kattsanden.
- Koppla inte SmartSpin™ i väggen genast, i vissa fall är det en bra idé att lämna den nya kattlådan urkopplad tills din kisse får kläm på det.

Din katt behöver ditt tålamod.

Viktigt: Om du har en kattunge, lämna kattlådan urkopplad (eller stäng av Auto Clean

funktion i appen) och ösa upp avfall manuellt tills hon väger minst 1 kg (2,5 pund) och är minst 6

månader gammal. Du kanske vill placera en låda eller annan höjd framför kattlådan för att göra det enklare för hen ska lätt kunna komma in och ut.

Vad du har,

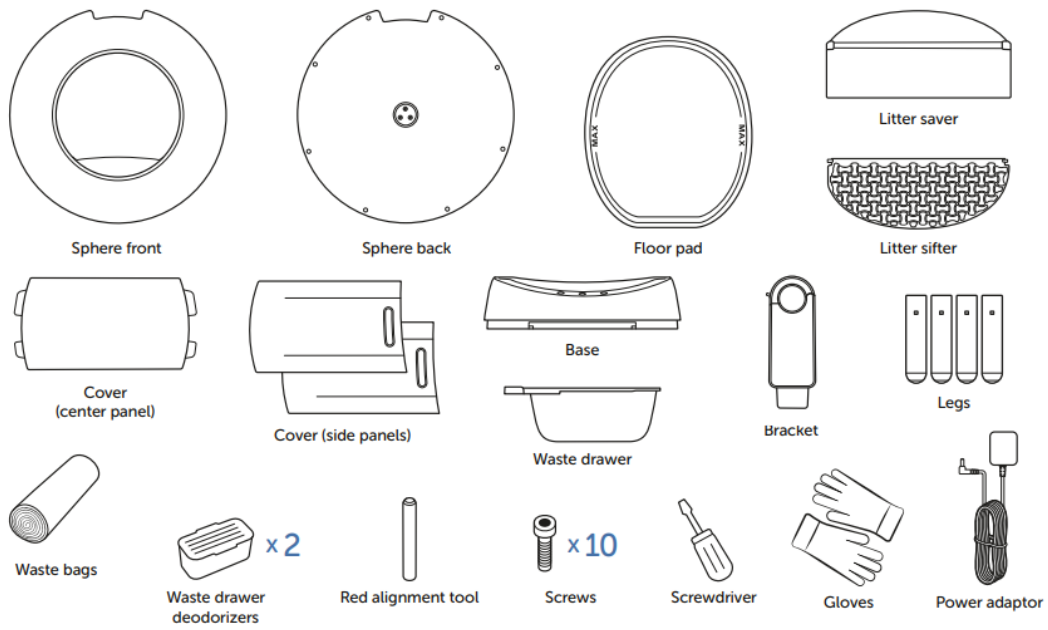

Vad du behöver:

- Trådlös router (2,4 GHz)
- Hög hastighetsanslutning till internet
- Smartphone

Montera kattsandlådan enligt bilderna

1 Assemble the base

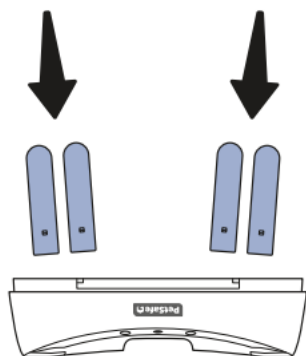

2

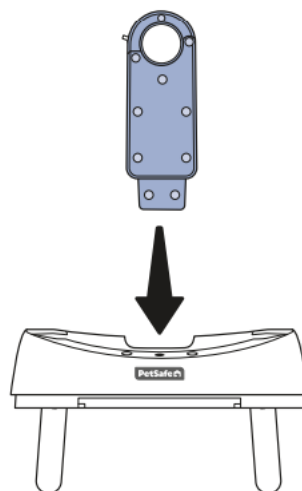

3



4

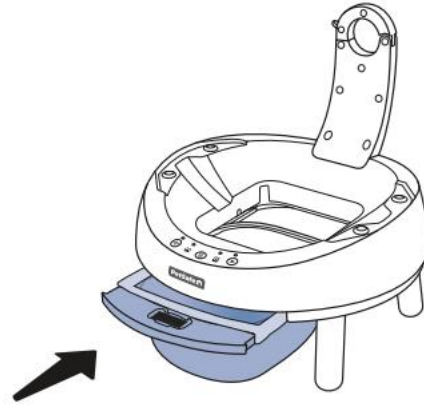

5 Assemble the sphere

6

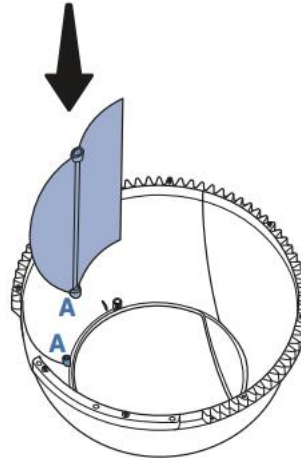
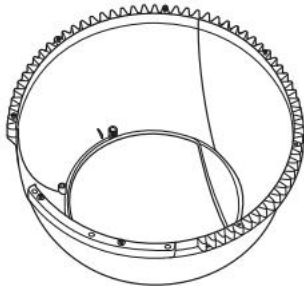

7

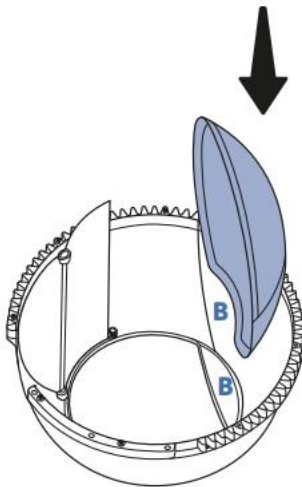

8

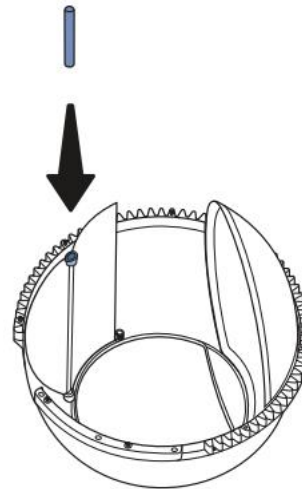

9

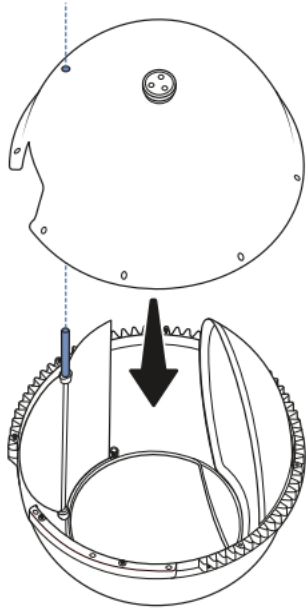

10

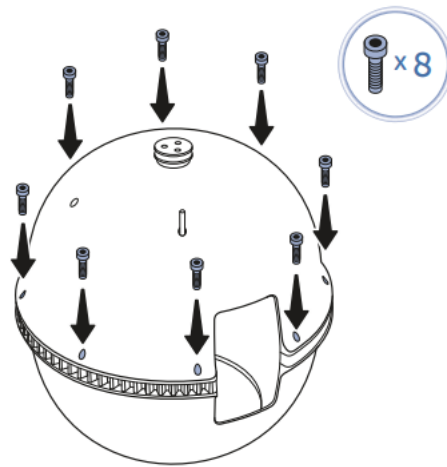

11 Install the litter sifter

12

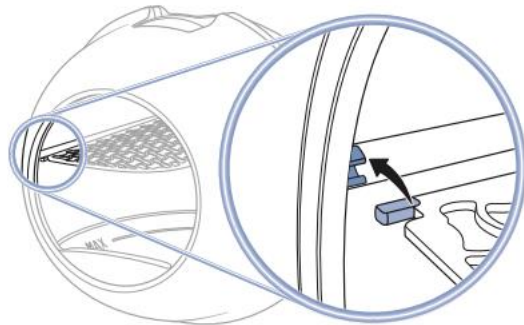
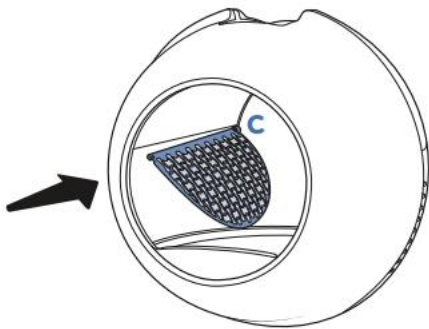

13 Place the sphere on the base

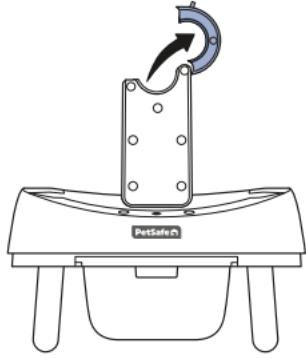

14

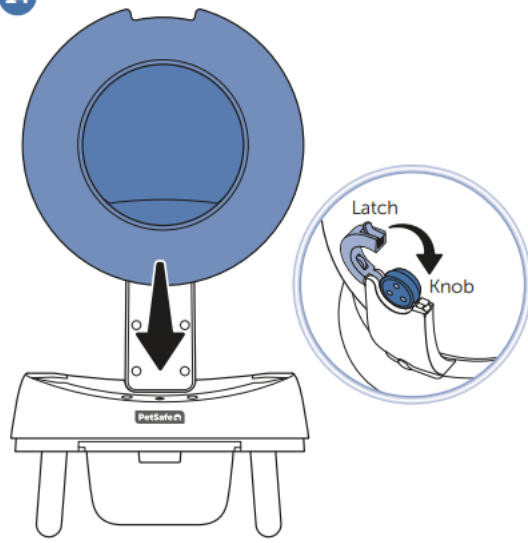

15 Assemble the cover

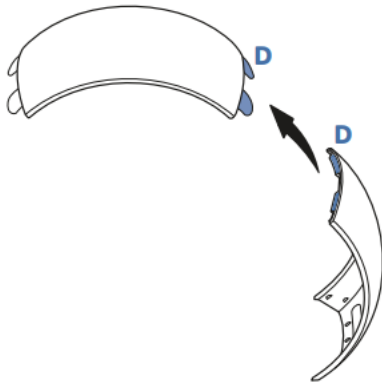

16

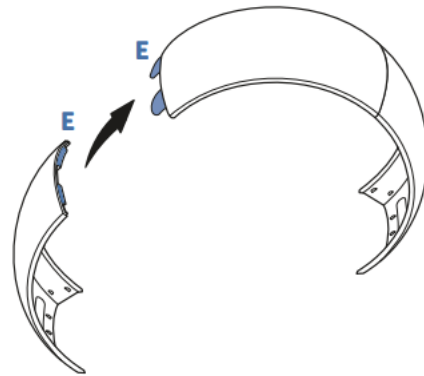

17 Install the cover



18 Plug in the litter box

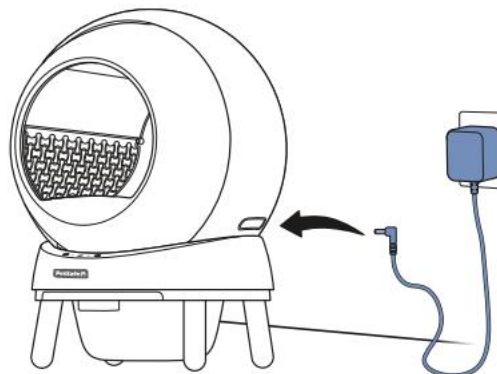

19 Add litter

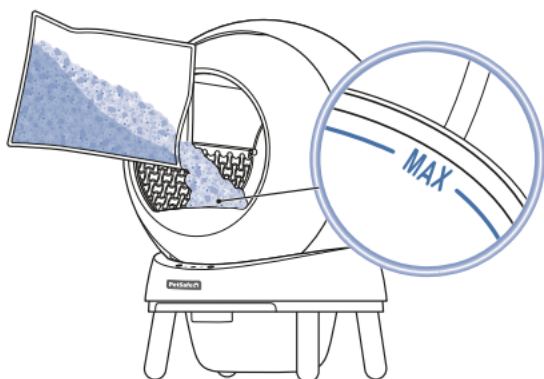

20 Download the app and connect



Skanna QR-koden ovan för att ladda ner PetSafe® SmartSpin™-appen.

När du har laddat ner och öppnat appen trycker du på och håll in Wi-Fi-knappen på kattlådan i 3 sekunder för att koppla ihop dem. Wi-Fi-lampan börjar blinka. I appen följer du instruktionerna på skärmen och anslut den till ditt Wi-Fi-nätverk. När kattlådan är ansluten kommer Wi-Fi-lampan att fortsätta lysa.

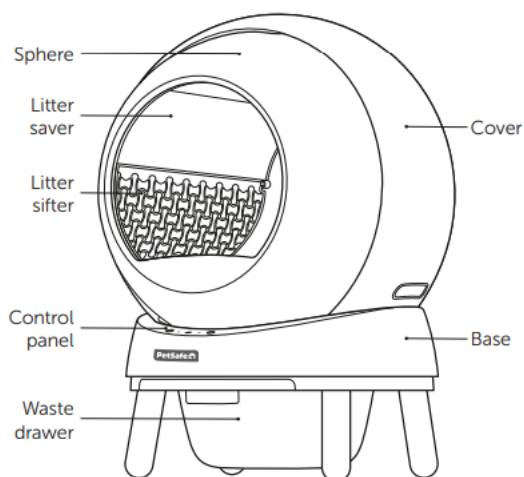

- En viktsensor inuti kattlådan känner av när din katt är närvarande. Lampa kommer att tändas när en viktförändring på mer än 2,5 pund (1kg) är upptäckt.
- När din katt lämnar kattlådan, rengöringslampan börjar blinka och rengöringstimern startar en 3-minuters nedräkning. (Du kan ändra längden på denna nedräkning i appen.)
- När nedräkningen är klar kommer kattlådan att starta rengöringen. Sfären kommer långsamt att rotera 180 grader. När sfären roterar kommer oanvänt skräp att falla genom strösilen och förvaras. Klumpat skräp och avfall kommer att ligga kvar ovanpå strösilen och hamna i avfallslådan. Sfären kommer sedan att rotera tillbaka till sin startposition, fördela det oanvända ströet jämnt över botten av kattlådan.
- Om din katt återvänder till kattlådan under nedräkningen, kommer både sfären och timern att stanna. Nedräkningstimern återställs när din katt lämnar kattlådan igen.

- Du kan starta rengöringscykeln när som helst genom att trycka på rengöringsknappen i 1 sekund. För att pausa rengöringscykeln, tryck på rengöringsknappen igen. (Du kan också starta och stoppa rengöringscykeln i appen.)

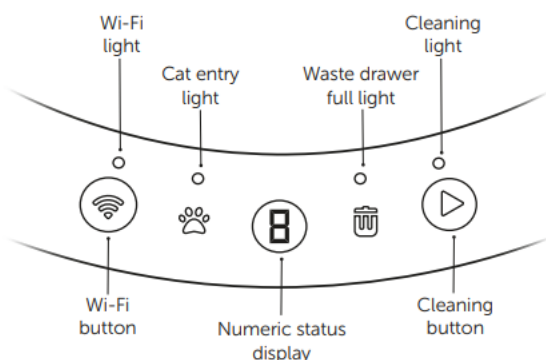

Button	Usage
Wi-Fi button	Press and hold this button for 3 seconds to enter pairing mode.
Cleaning button	Press the cleaning button for 1 second to manually start the cleaning cycle. To pause or resume the cleaning cycle while it is in progress, press the cleaning button again. Press and hold the cleaning button for 3 seconds to enter Add Litter mode. After adding litter to the litter box, press the cleaning button again to exit Add Litter mode.

Light	Meaning
Wi-Fi light	<ul style="list-style-type: none"> • Solid white: The litter box is connected to Wi-Fi. • Blinking white: The litter box is not connected to Wi-Fi.
Cat entry light	<ul style="list-style-type: none"> • Solid white: A weight change of more than 2.5 lb (1.1 kg) has been detected. • Off: No weight change has been detected.
Waste drawer full light	<ul style="list-style-type: none"> • Solid white: The waste drawer is full. • Off: The waste drawer is not full.
Cleaning light	<ul style="list-style-type: none"> • Solid white: The cleaning cycle is in progress. • Blinking white: The cleaning cycle countdown has been initiated.
Numeric status display	<p>This display provides information about the litter box operating mode and alerts you to any error conditions:</p> <ul style="list-style-type: none"> • A: Add Litter mode is enabled. • L: Child lock is enabled; the control panel buttons are locked. • P: Sleep mode is enabled; the litter box will not run the cleaning cycle during the selected time period. • 1: The infrared sensor in the base is blocked. • 2: The cover is not installed. • 3: Abnormal motor current. • 4: Sphere not installed. <p>See the app for more information about litter box operating modes and error conditions.</p>

Töm och lägg till färsk sand så här,

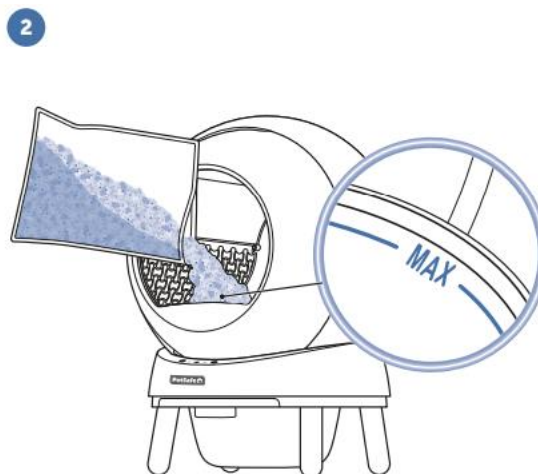
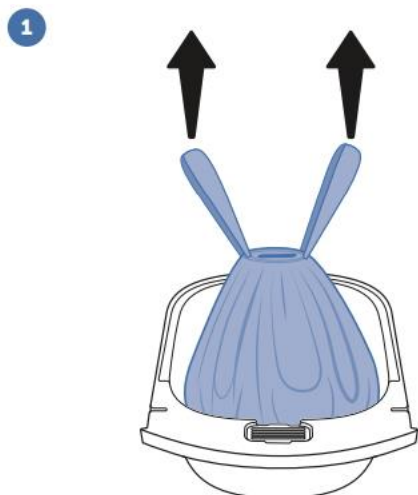

Putsa SmartSpin så här

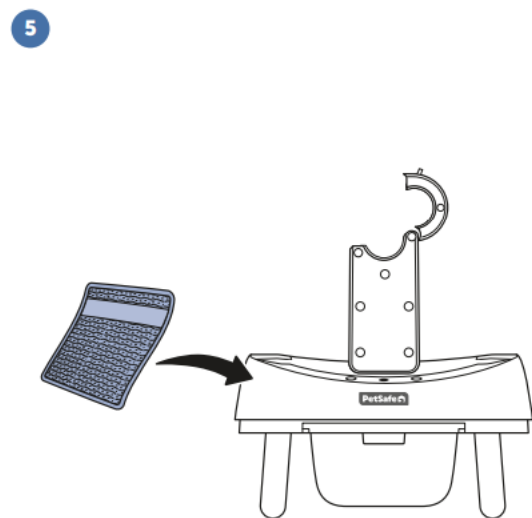
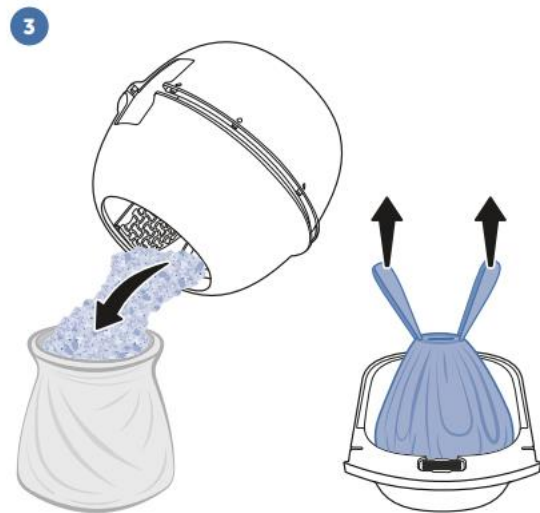
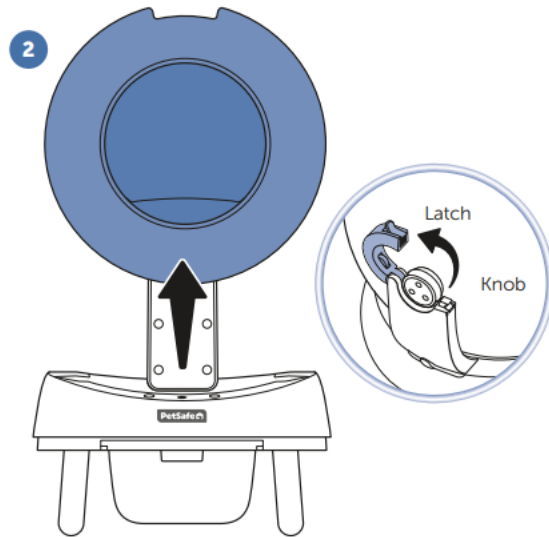
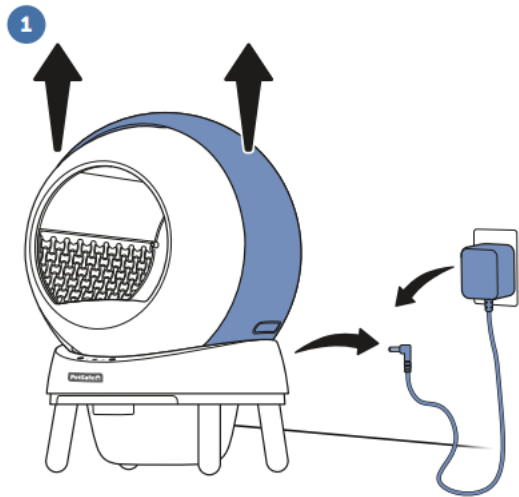

Tips och tricks

Då du lägger till kattsand ska du använda "add litter" funktionen om där redan finns tillräckligt

kommer inte "A" att visas.. Då A synns då finns där för lite.. Andra länken visar hur ni kan göra en reset.

Vi har sällan krångel med dessa så kan du snälla ta ut strömkabeln från väggen och smart spin. Sätt tillbaka strömkabeln och kolla att det inte är fast i en trasig förlängare eller liknande. Kolla att delen som ska in i Smart Spin är tillräckligt långt intryckt.

Mera tips här,

<https://support.petsafe.net/articles/my-petsafe-smartspin-self-cleaning-litter-box-will-not-go-into-add-litter-mode/>

och om det inte fungerar snälla testa detta.

<https://support.petsafe.net/articles/my-petsafe-scoopfree-smartspin-self-cleaning-litter-box-will-not-clean/>

Kontakta kundtjänst <https://intl.petsafe.net/en-dk/support/contact-us>

PS : [PAC00-17984](#) Scoopfree Clumping Waste Bin Liners (x25) tillgängliga

ScoopFree™ SmartSpin™

Self-Cleaning Litter Box



Kun asennat uutta hiekkalaatikkoa, muista:

Vaikka monet kissat ottavat heti käyttöön uuden ja parannetun hiekkalaatikon, toisille kestää vähän pidempään tottua uuteen kissavessaan. Tässä on muutamia vinkkejä, joiden avulla pääset näppärästi alkuun:

- Aseta uusi SmartSpin™ itsepuhdistuva hiekkalaatikko nykyisen hiekkalaatikon viereen. (Mistä pääset kohta eroon).
- Anna vanhan hiekkalaatikon likaantua. Useimmat kissat pitävät puhtaasta hiekkalaatikosta, ja auttaa kissaa arvostamaan uutta Smart Spinin puhdasta hiekkaa.
- Vaikka SmartSpin™ itsepuhdistuva hiekkalaatikko on hiljainen, joissain tapauksissa on hyvä idea jättää uusi hiekkalaatikko käynnistämättä, kunnes kissasi tajuaa jujun.

Kissasi tarvitsee ensimmäisellä viikolla vähän kärsivällisyyttä.

Tärkeää: Jos sinulla on kissanpentu, jätä hiekkalaatikko irti pistorasiasta (tai sammuta automaattinen puhdistus) ja puhdista itse kissavessaa, kunnes kissasi painaa vähintään 1kg ja

on ainakin 6 kuukautta vanha. Kissanpennulle on helpompaa kävellä SmartSpinin sisälle jos on jokin koroke sen edessä.

Mitä sinulla on,

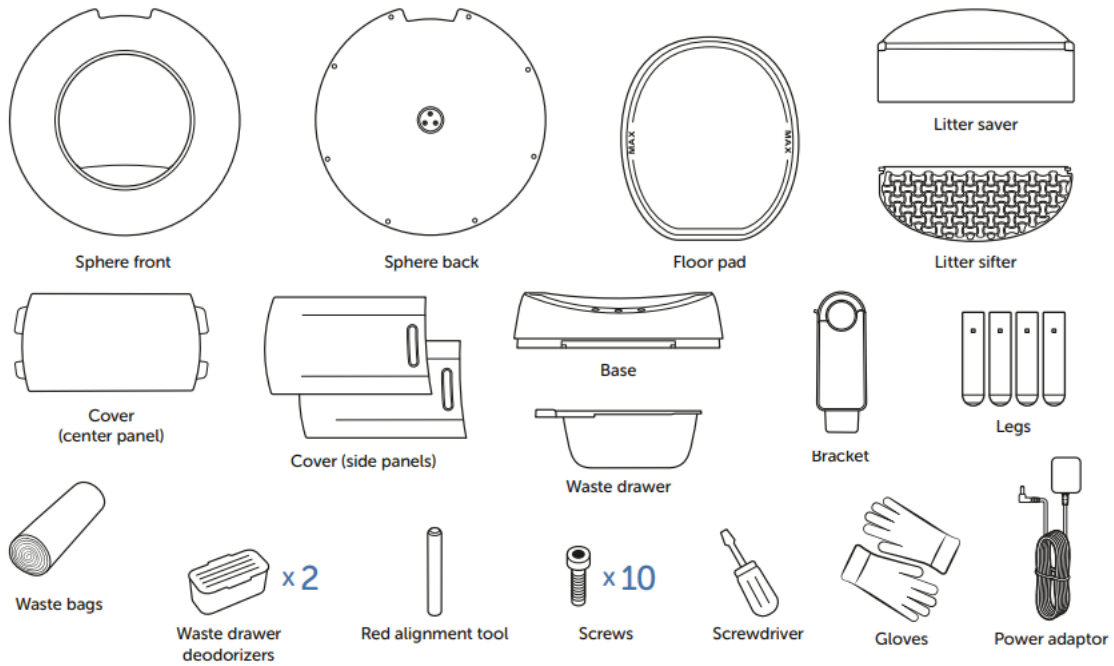

Mitä tarvitset:

- Langaton reititin (2,4 GHz)
- Nopea internetyhteys
- Älypuhelin

Asenna kissavessa kuvien mukaisesti

1 Assemble the base

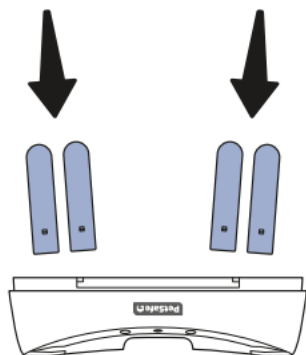

2

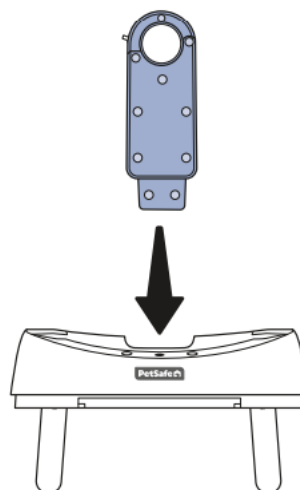

3



4

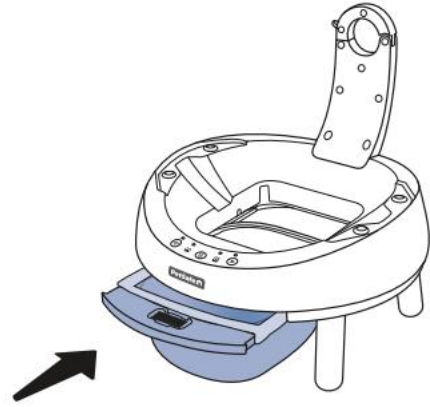

5 Assemble the sphere

6

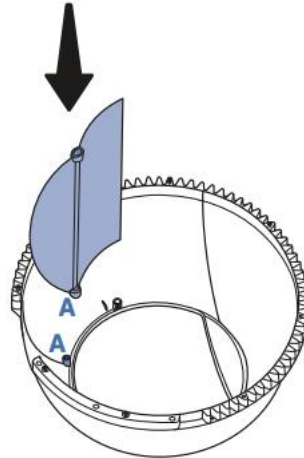
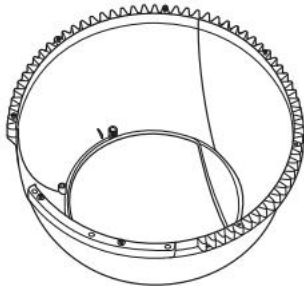

7

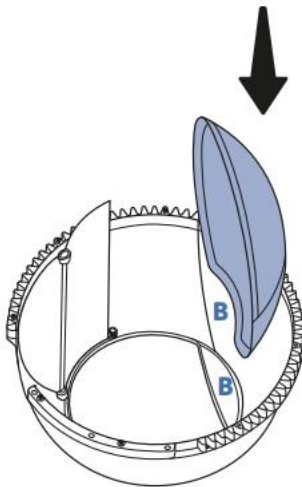

8

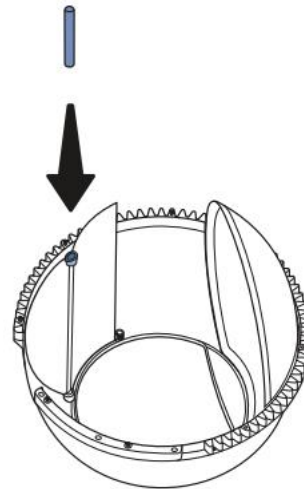

9

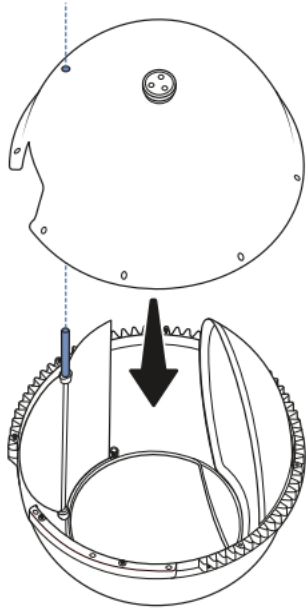

10

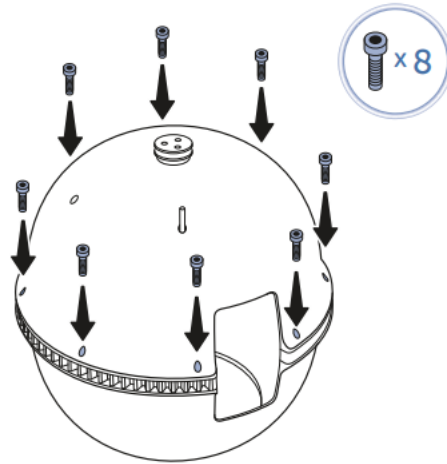

11 Install the litter sifter

12

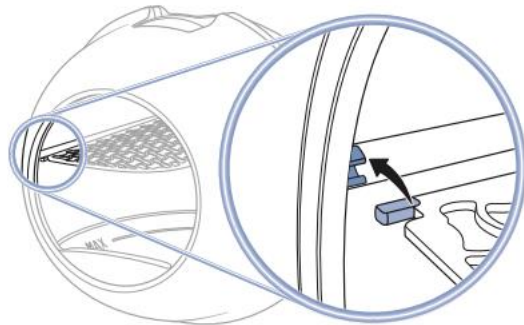
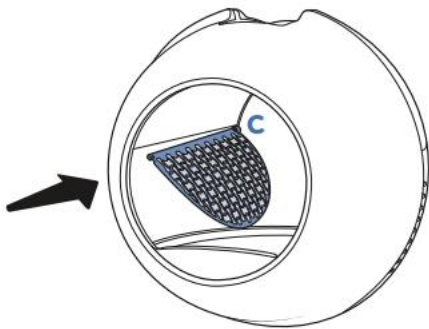

13 Place the sphere on the base

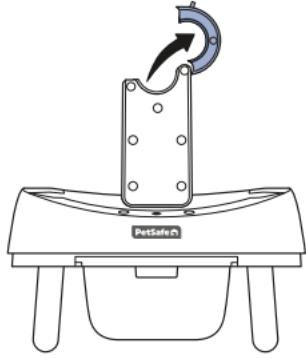

14

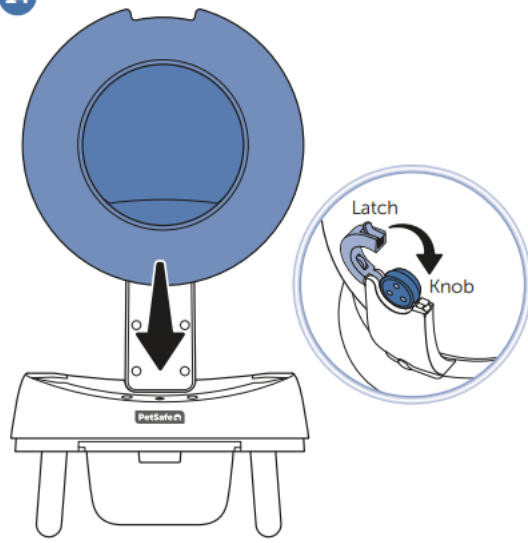

15 Assemble the cover

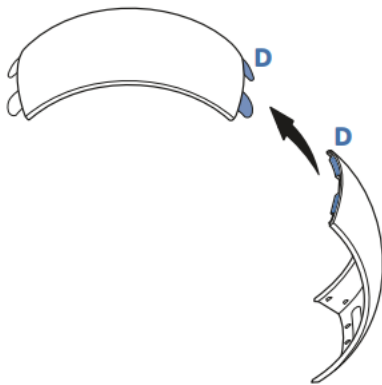

16

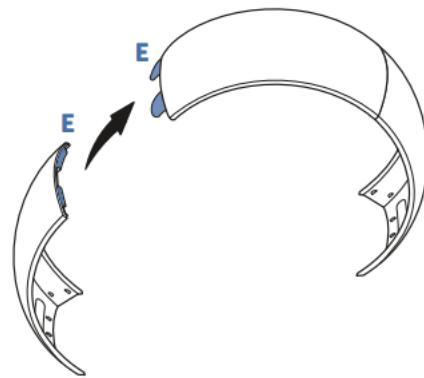

17 Install the cover



18 Plug in the litter box

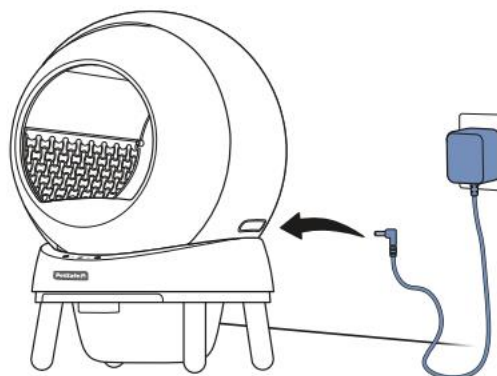

19 Add litter

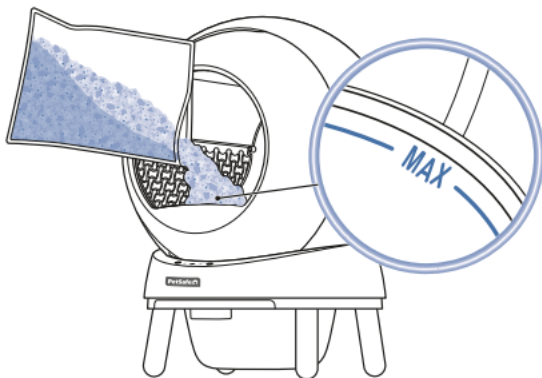

20 Download the app and connect



Skannaa yllä oleva QR-koodi ladataksesi PetSafe® SmartSpin™ -sovellus.

Kun olet ladannut ja avannut sovelluksen, paina ja pidä hiekkalaatikon Wi-Fi-painiketta painettuna 3 sekunnin ajan. Wi-Fi-valo syttyy. Lisää tiedot kissastasi noudattamalla sovelluksessa näytön ohjeita ja yhdistä se Wi-Fi-verkkoosi.

Kun hiekkalaatikko on kytketty, Wi-Fi-valo lakkaa vilkkumasta.

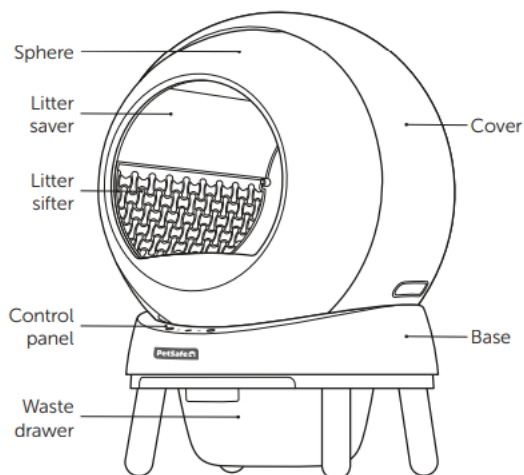

- Hiekkalaatikon sisällä oleva painotunnistin tunnistaa milloin kissasi on paikalla. Valo syttyy kun painon muutos on yli 2,5 puntaa (1kg) havaittu.
- Kun kissasi lähtee hiekkalaatikosta, valo sammuu, puhdistusvalo alkaa vilkkua ja puhdistusajastin käynnistää 3 minuutin lähtölaskennan. (Voit muuttaa tämän laskurin pituutta sovelluksessa.)
- Kun lähtölaskenta on valmis, hiekkalaatikko käynnistää puhdistusjakson. SmartSpin pyörii hitaasti 180 astetta. Kun pallo pyörii, käyttämätön hiekka menee seulan läpi ja pinnalle jää paakkuuntunut roskat ja jätteet, mitä joutuu jätelatikkoon. SmartSpin kääntyy sitten takaisin lähtöasentoonsa, levittää käyttämättömät hiekat tasaisesti pohjalle
- Jos kissasi palaa hiekkalaatikon lähtölaskennan aikana, Smart Spin ja ajastin pysähtyy. Ajastin nollautuu kun kissasi lähtee taas hiekkalaatikosta.

- Voit aloittaa puhdistusjakson milloin tahansa painamalla puhdistuspainiketta 1 sekunnin ajan. Voit keskeyttää puhdistusjakson aina painamalla puhdistuspainiketta uudelleen. (Voit myös aloittaa ja lopeta puhdistusjakso sovelluksessa.)

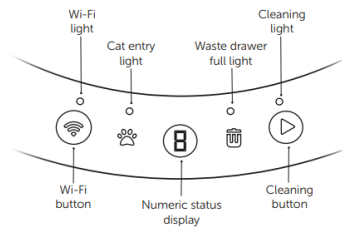

Light	Meaning
Wi-Fi light	<ul style="list-style-type: none"> • Solid white: The litter box is connected to Wi-Fi. • Blinking white: The litter box is not connected to Wi-Fi.
Cat entry light	<ul style="list-style-type: none"> • Solid white: A weight change of more than 2.5 lb (1.1 kg) has been detected. • Off: No weight change has been detected.
Waste drawer full light	<ul style="list-style-type: none"> • Solid white: The waste drawer is full. • Off: The waste drawer is not full.
Cleaning light	<ul style="list-style-type: none"> • Solid white: The cleaning cycle is in progress. • Blinking white: The cleaning cycle countdown has been initiated.
Numeric status display	<p>This display provides information about the litter box operating mode and alerts you to any error conditions:</p> <ul style="list-style-type: none"> • A: Add Litter mode is enabled. • L: Child lock is enabled; the control panel buttons are locked. • P: Sleep mode is enabled; the litter box will not run the cleaning cycle during the selected time period. • 1: The infrared sensor in the base is blocked. • 2: The cover is not installed. • 3: Abnormal motor current. • 4: Sphere not installed. <p>See the app for more information about litter box operating modes and error conditions.</p>

Button	Usage
Wi-Fi button	Press and hold this button for 3 seconds to enter pairing mode.
Cleaning button	Press the cleaning button for 1 second to manually start the cleaning cycle. To pause or resume the cleaning cycle while it is in progress, press the cleaning button again. Press and hold the cleaning button for 3 seconds to enter Add Litter mode. After adding litter to the litter box, press the cleaning button again to exit Add Litter mode.

Tyhjennä jätelaatikko ja lisää uusi hiekka näin,

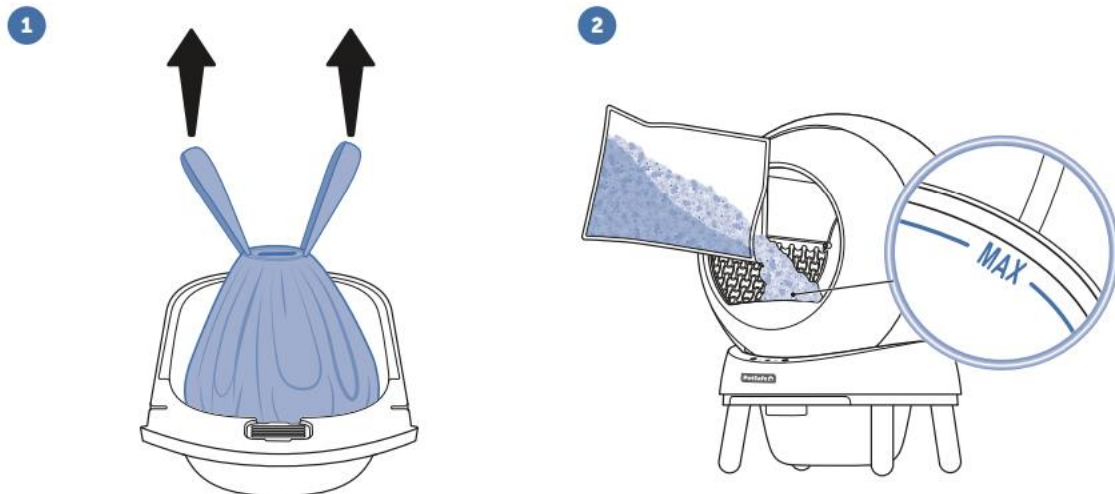

Puhdista kissavessa näin,

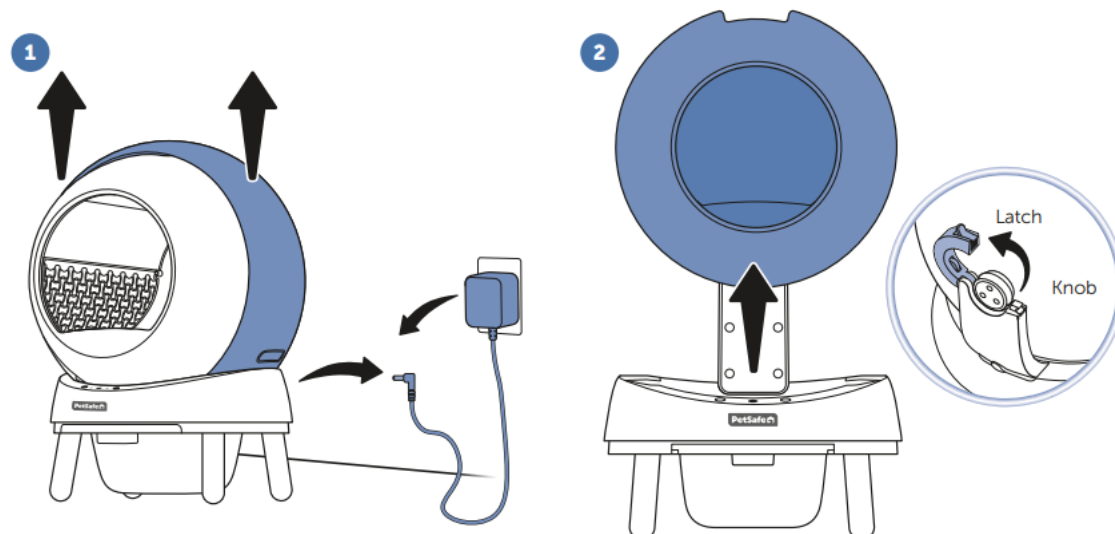

3

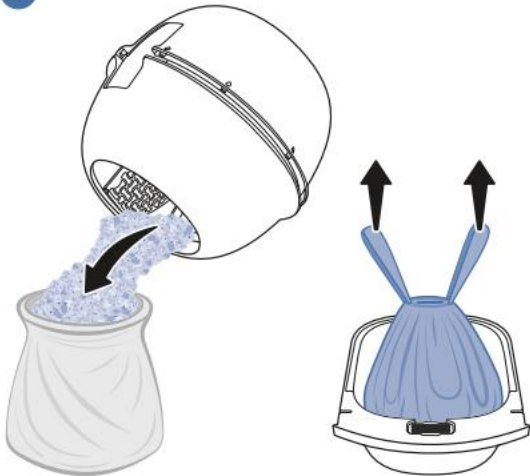

4

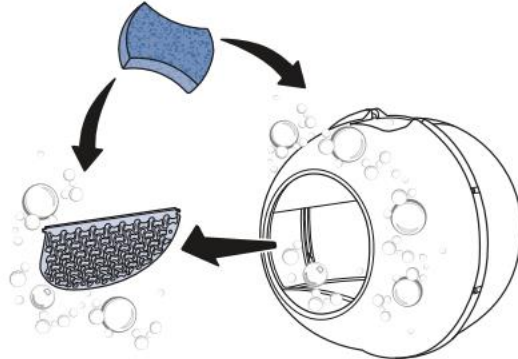

5

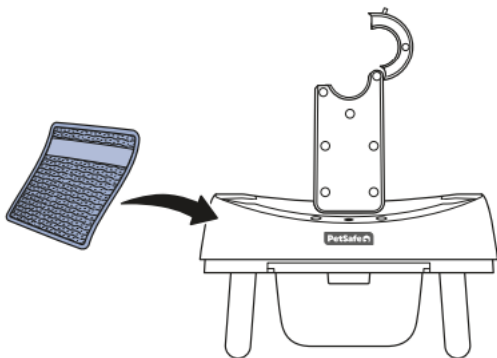

6

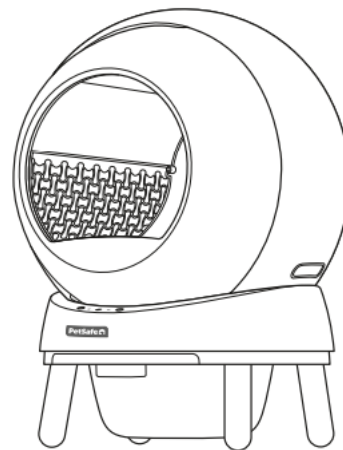

Vinkkejä ja niksejä

Kun lisää kissanhiekkää, kannattaa käyttää "lisää kissanhiekkää" -toimintoa, jos hiekkää on jo tarpeeksi, "A" ei näy.. Kun A on näkyvässä, sitä on liian vähän. Alla olevassa linkissä näkyy kuinka voit nollata sen.

Meillä on harvoin ongelmia näiden kanssa, joten jos jotain lakkaa toimimasta - voitko vetää virtajohtoa irti seinästä. Liitä virtajohto takaisin pistorasiaan ja tarkista, ettei se ole juuttunut katkenneeseen jatkojohtoon, sovittimeen tai vastaavaan. Tarkista, että Smart Spiniin osat ja virtajohto on työnnetty tarpeeksi sisään.

Lisää vinkkejä täältä,

<https://support.petsafe.net/articles/my-petsafe-smartspin-self-cleaning-litter-box-will-not-go-into-add-litter-mode/>

ja jos se ei toimi niin kokeile tätä.

<https://support.petsafe.net/articles/my-petsafe-scoopfree-smartspin-self-cleaning-litter-box-will-not-clean/>

Ota yhteyttä asiakaspalveluun <https://intl.petsafe.net/en-dk/support/contact-us>

PS : PAC00-17984 Scoopfree Clumping Waste Bin Liners (x25) saatavilla

ScoopFree™ SmartSpin™ **Self-Cleaning Litter Box**



Når du setter opp den nye søppelboksen, husk:

Noen katter trenger

tid til å justere

Mens mange katter tar til sin nye og forbedrede søppelkasse med en gang, tar andre litt lengre. Her er noen tips for å hjelpe deg å komme godt i gang:

- Plasser din nye ScoopFree™ SmartSpin™ selvrensende søppelkasse ved siden av kattens nåværende søppelkasse. (Du kan snart bli kvitt den gamle).
- La den gamle søppelboksen bli skitten. De fleste katter foretrekker en ren søppelkasse og vil snart bli trukket til det ferske kullet.
- Selv om ScoopFree™ SmartSpin™ selvrensende søppelkasse er stillegående når du løper og går kun etter bruk, i noen tilfeller er det en god idé å la den nye søppelboksen være koblet fra strømmettet

til pusen din får taket på det.

Kattungen din trenger

spesiell omsorg

Viktig: Hvis du har en kattunge, la søppelboksen være frakoblet (eller slå av Auto Clean funksjon i appen) og øse opp avfall manuelt til hun veier minst 1,1 kg og 6

måneder gammel. Det kan være lurt å plassere en boks eller gå foran søppelboksen for å gjøre det enklere

for at hun skal komme inn og ut.

Hva du har:

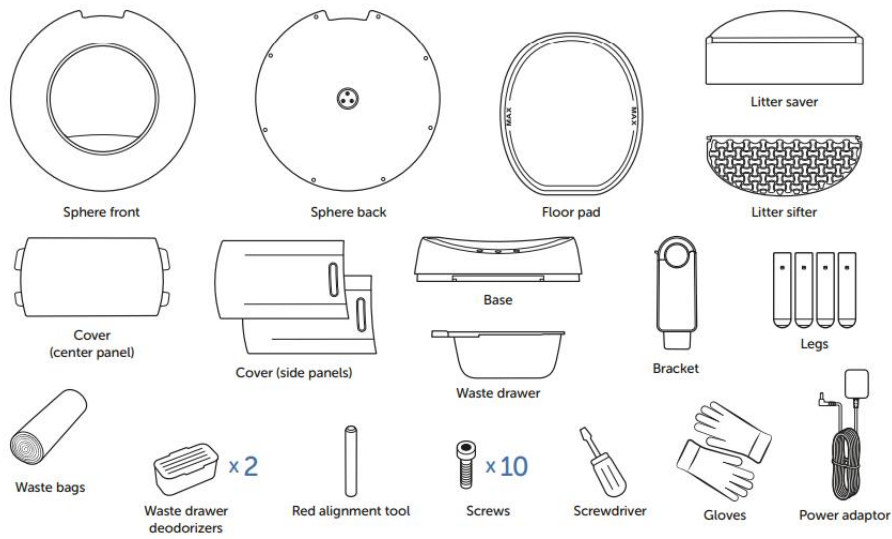

Dette trenger du:

- Trådløs ruter (2,4 GHz)
- Høyhastighets Internett-tilkobling
- Smarttelefon

Sette opp kattetoiletet etter bildene

1 Assemble the base

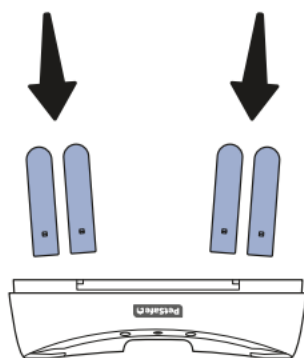

2

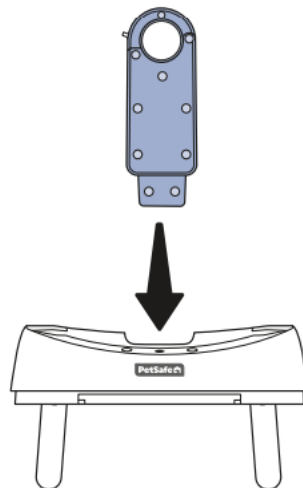

3



4

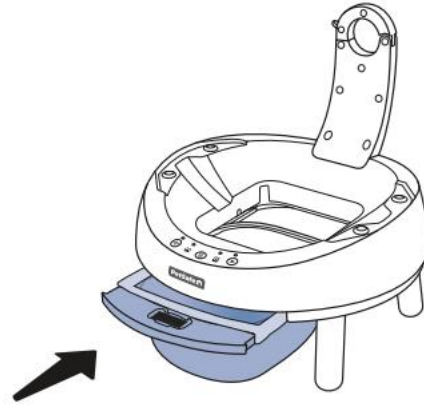

5 Assemble the sphere

6

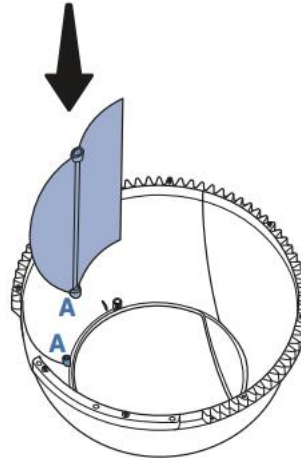
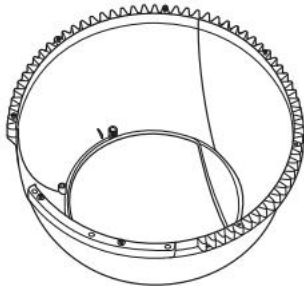

7

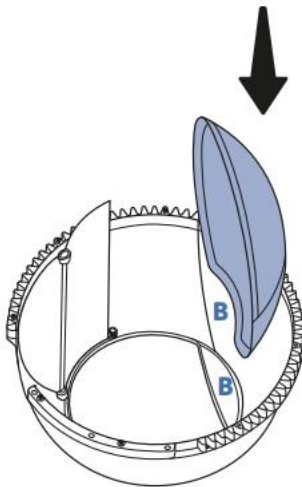

8

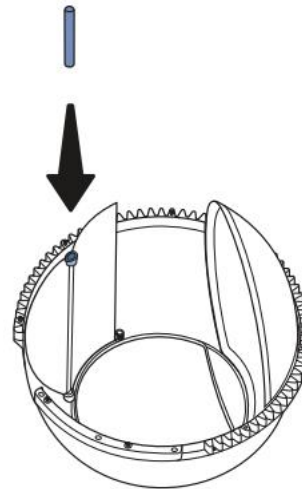

9

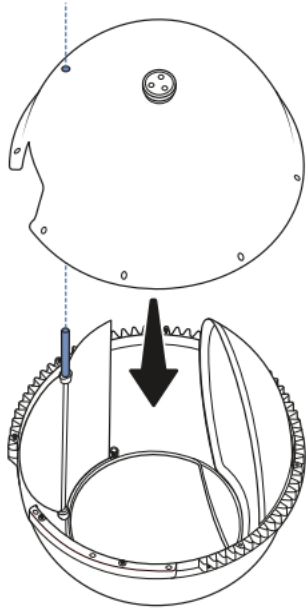

10

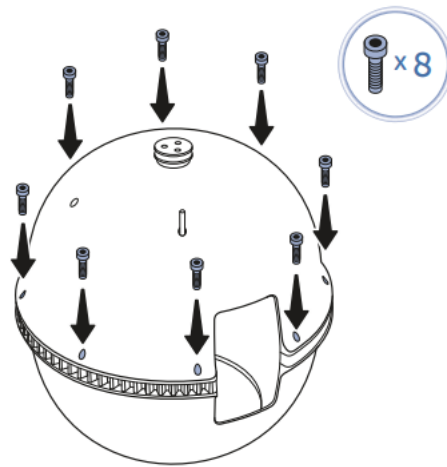

11 Install the litter sifter

12

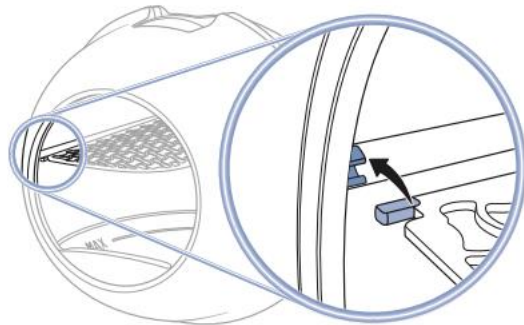
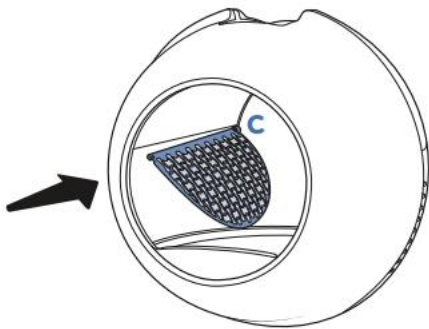

13 Place the sphere on the base

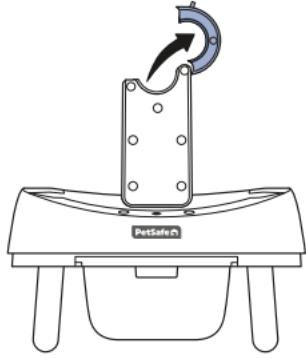

14

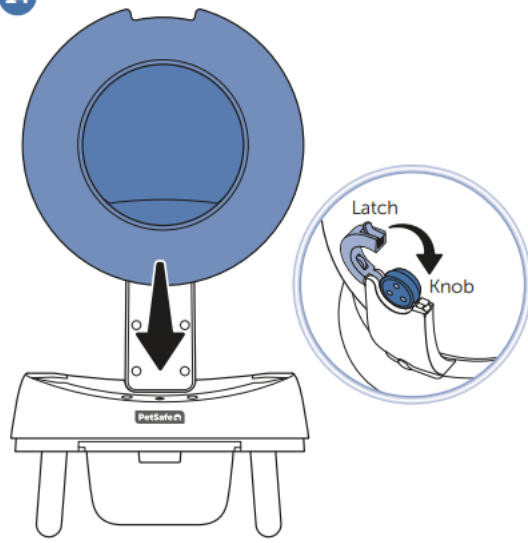

15 Assemble the cover

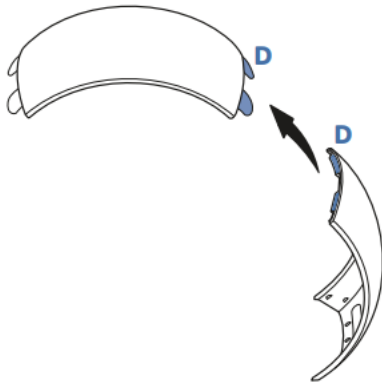

16

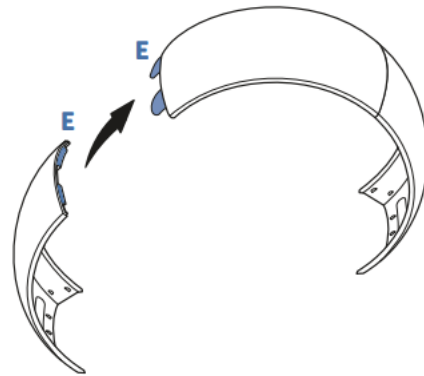

17 Install the cover



18 Plug in the litter box

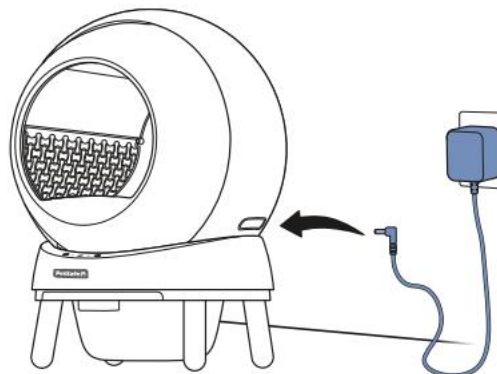

19 Add litter

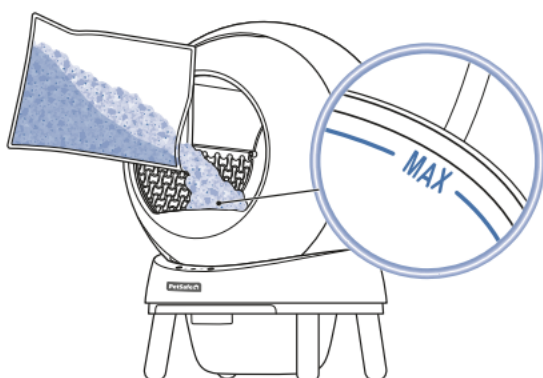

20 Download the app and connect



Skann QR-koden ovenfor for å laste ned PetSafe® SmartSpin™-appen.

Når du har lastet ned og åpnet appen, trykk og hold inne Wi-Fi-knappen på søppelboksen i 3 sekunder for å gå inn i paringsmodus. Wi-Fi-lyset begynner å blinke.

I appen følger du instruksjonene på skjermen for å legge til søppelet boksen til appen og koble den til Wi-Fi-nettverket.

Når søppelboksen er tilkoblet, vil Wi-Fi-lyset lyse fast.

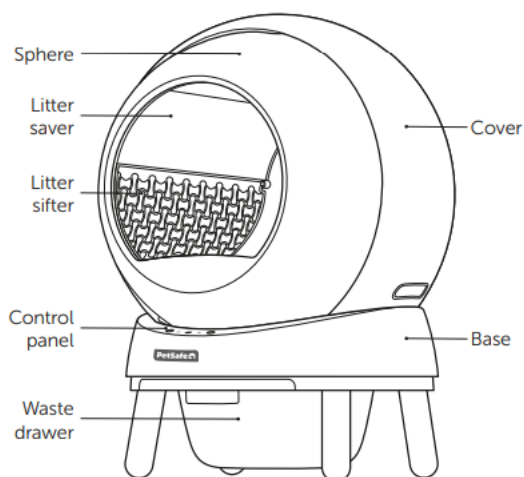

- En vektsensor inne i søppelboksen registrerer når katten din er tilstede. Katteinngangslýset vil lyse når en vektendring på mer enn 2,5 pund (1,1 kg) er oppdaget.
- Når katten din forlater søppelboksen, lyser katteinngangen vil slå seg av, rengjøringslyset begynner å blinke, og

rengjøringsstidtakeren starter en 3-minutters nedtelling. (Du kan endre lengden på denne nedtellingen i appen.)

- Når nedtellingen er fullført, vil søppelboksen start rengjøringscyklusen. Kulen vil sakte rotere 180 grader. Når kulen roterer, vil ubrukt søppel falle gjennom søppelsilen og oppbevares bak søppelet sparer. Klumpet søppel og avfall vil forbli oppå søppelsilen og deponeres i avfallsskuffen. Kulen vil da rotere tilbake til utgangsposisjonen, spre det ubrukte søppelet jevnt over bunnen av søppelkasse.

- Hvis katten din kommer tilbake til søppelboksen under nedtellingen, timeren vil stoppe. Nedtellingstidtakeren tilbakestilles når katten din forlater søppelboksen igjen.

- Du kan starte rengjøringscyklusen når som helst ved å trykke på renseknapp i 1 sekund. For å sette rengjøringscyklusen på pause, trykk på renseknappen igjen. (Du kan også starte og stopp rensesyklusen i appen.)

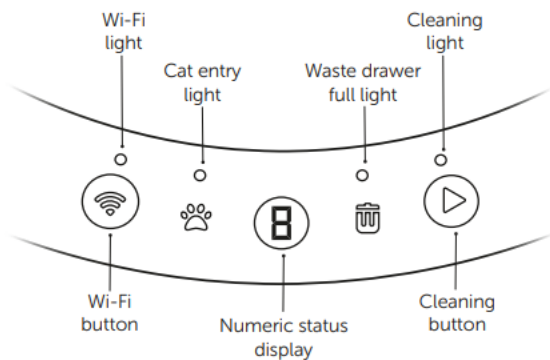

Button	Usage
Wi-Fi button	Press and hold this button for 3 seconds to enter pairing mode.
Cleaning button	Press the cleaning button for 1 second to manually start the cleaning cycle. To pause or resume the cleaning cycle while it is in progress, press the cleaning button again. Press and hold the cleaning button for 3 seconds to enter Add Litter mode. After adding litter to the litter box, press the cleaning button again to exit Add Litter mode.

Light	Meaning
Wi-Fi light	<ul style="list-style-type: none"> • Solid white: The litter box is connected to Wi-Fi. • Blinking white: The litter box is not connected to Wi-Fi.
Cat entry light	<ul style="list-style-type: none"> • Solid white: A weight change of more than 2.5 lb (1.1 kg) has been detected. • Off: No weight change has been detected.
Waste drawer full light	<ul style="list-style-type: none"> • Solid white: The waste drawer is full. • Off: The waste drawer is not full.
Cleaning light	<ul style="list-style-type: none"> • Solid white: The cleaning cycle is in progress. • Blinking white: The cleaning cycle countdown has been initiated.
Numeric status display	<p>This display provides information about the litter box operating mode and alerts you to any error conditions:</p> <ul style="list-style-type: none"> • A: Add Litter mode is enabled. • L: Child lock is enabled; the control panel buttons are locked. • P: Sleep mode is enabled; the litter box will not run the cleaning cycle during the selected time period. • 1: The infrared sensor in the base is blocked. • 2: The cover is not installed. • 3: Abnormal motor current. • 4: Sphere not installed. <p>See the app for more information about litter box operating modes and error conditions.</p>

Tøm avfallsskuffen og tilsett ferskt søppel

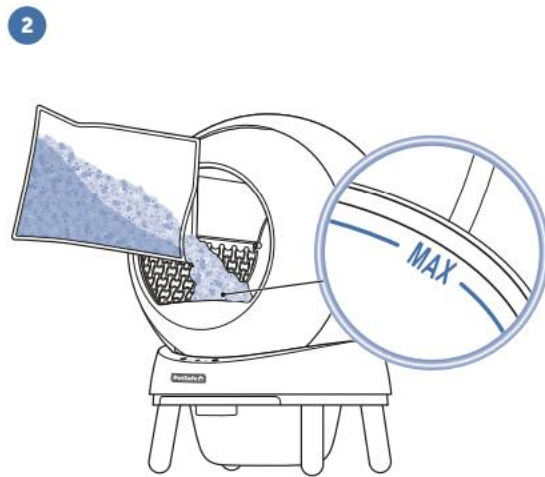
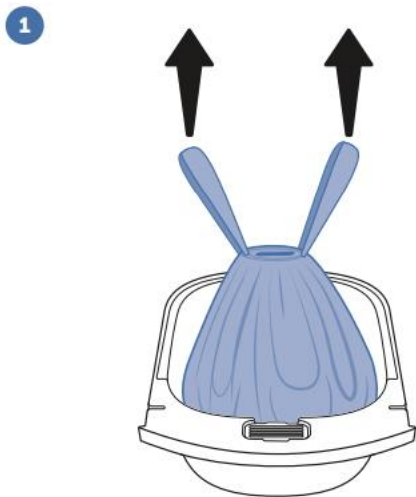

rengjør det slik

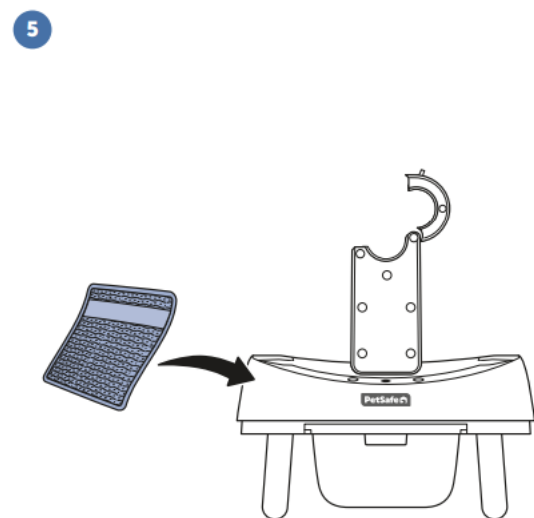
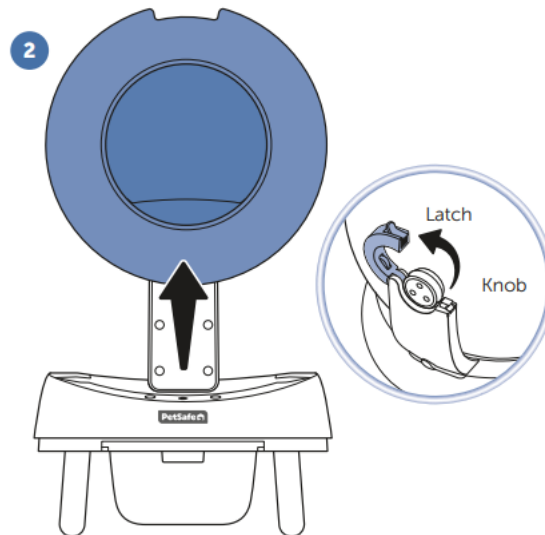
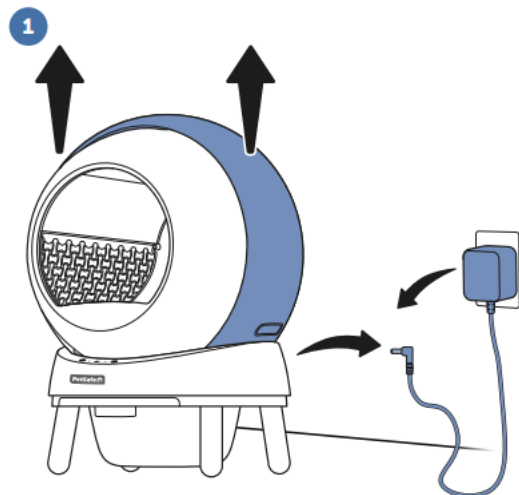

Tips og triks

Når du legger til kattesand bør du bruke funksjonen "legg til kattesand" hvis det allerede er nok, "A" vises ikke.. Når A er synlig er det for lite.. Den andre lenken viser hvordan du kan tilbake stille den.

Vi har sjelden problemer med disse, så kan du dra strømledningen ut av veggen og snurre. Plugg inn strømkabelen igjen og kontroller at den ikke sitter fast i en ødelagt skjøteledning eller lignende. Sjekk at delen som skal inn i Smart Spin er skjøvet langt nok inn.

Flere tips her,

<https://support.petsafe.net/articles/my-petsafe-smartspin-self-cleaning-litter-box-will-not-go-into-add-litter-mode/>

og hvis det ikke fungerer, prøv dette.

<https://support.petsafe.net/articles/my-petsafe-scoopfree-smartspin-self-cleaning-litter-box-will-not-clean/>

Kontakt kundeservice <https://intl.petsafe.net/en-dk/support/contact-us>

PS : PAC00-17984 Scoopfree Clumping Waste Bin Liners (x25) tilgjengelig

